

BONGSHIN

OPERATIONAL MANUAL

CE



BS-205
DIGITAL INDICATOR

CONTENTS

Introductions	2
The Features of BS-205 . . .	3
Technical Specification . . .	4
Dimensions	6
Front Panel	7
Rear Panel	9
Parameter	16
ZERO Calibration	21
Actual Load Calibration . . .	22
Equivalent Calibration . . .	24
Comparator Data	26
Hold Function	34
Key Lock	36
Option	37
Error Message and Trouble Shooting . . .	47

1. Introduction

Thank you for purchasing BS-205 High precision digital indicator.

Check for any breakdown during transit and discrepancy of the specification. Always keep this manual at hand.

The BS-205 Series are configured as follows :

Check that there is no discrepancy between the model and its specifications you have chosen when ordering and the model and its specifications under your hand.

In order to obtain the highest performance of your BS-205, thoroughly read this manual before use.

2. Precautions

- Place the indicator on a flat and stable surface.
- Applying voltage and current exceeding the maximum permissible value results in the breakdown of the meter.
- Do not severely press because the light pressing of keys can incite the operation.
- Do not subject the scale to sudden temperature changes.
Operating temperature : $-10^{\circ}\text{C}\sim+50^{\circ}\text{C}$
- Keep the scale away from strong EMI noises may cause incorrect weight readings.
- Keep the main body from rain and keep in dry area.
- Do not use inflammable materials in cleaning.
- The contents of this manual are subject to change without notice for further improvement.

The Features of BS-205

1. Features

- 24 bit Sigma-Delta A/D converter for high accuracy.
- Appropriate for weight and measurement system.
- Simple full digital calibration.
- Simulative (mV/V memory) or live load calibration.
- Watchdog circuitry (system restoration)
- Weight Back-up (power on actual weight)

2. Main Function

- Various specification of weight conversion speed.
(Digital Filter Function)
- 3 Set point relay output.
- Hold, peak hold and auto zero.
- Optional serial output or analog output.
- User can set the max. weight which users want to and division at one's disposal.

Technical Specification

1. Analog Input & A/D Conversion

Analog signal input range	0mV ~ ±30mV
Non-linearity	0.01% F.S. max.
Max. Display resolution	99,999d
Min. Input sensitivity	0.3μV/Digit (min.)
Temperature drift	Zero : ±0.1μV/°C RTI max. Span : 10ppm/°C max.
Load cell excitation Voltage	DC 5V ±5%, 60mA (350 ohm x 4 load cells)
Input Noise	±0.3μVp.p
Input Impedance	10MΩ
A/D converter	24bit Sigma-Delta
A/D internal resolution	Approx. 1,000,000
A/D sampling speed	50 times/sec
Display range	-19,999 ~ 99,999

2. Digital Part

Display	LED, 7 Segment 14.1mm high 5 Digits
Display speed	50 times/sec ~ 1 times/sec
Polarity indication (-)	"-" Minus sign
Annunciators	HOLD, ZERO, STABLE, Relay point(LO, OK, HI)
Display increments	1, 2, 5, 10, 20, 50, 100, 200 selectable
Decimal Point	Selectable to any points

3. Technical

Operating voltage	AC110,220V \pm 10%, 50/60Hz, or DC24V
Power consumption	Approx. 10VA
Operating temperature	-10°C ~ 50°C
Overall dimensions	96(W) x 48(H) x 136(D)
Weight	Approx. 530 g

4. Option

Standard	Relay 3CH Output
Option - 1	RS-232C (Serial output)
Option - 2	RS-422 (Serial output)
Option - 3	RS-485 (Serial output)
Option - 4	DC 0 ~ 10V (Analog output)
Option - 5	DC 4 ~ 20mA (Analog output)
Option - 6	BCD (Parallel output)

Example) Option- 4 : Relay 3CH + DC 0 ~ 10V

Dimensions

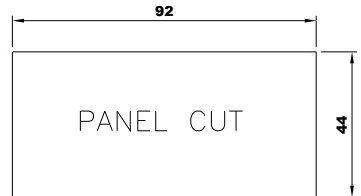
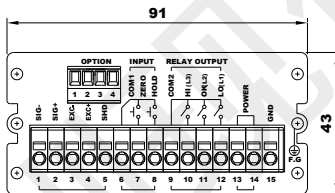
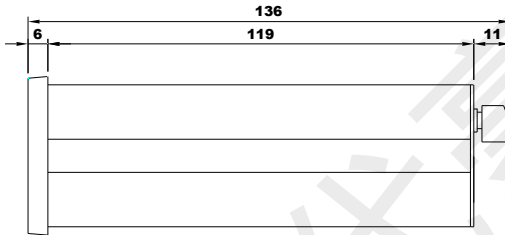
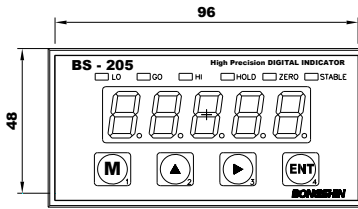

Dimensions for cutting panel

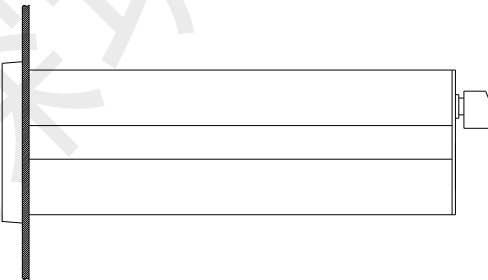

To mount the BS-205 to the panel, remove its fittings and insert it through the hole in the front of the panel. From the back of the panel, fix the product to the panel with the fittings.

2. Keyboard



- 1) Pressing the increments and mode keys together changes to the parameter setting mode.
- 2) Returns to the measurement mode.(ESC)
- 3) Selects the item to be set.



- 1) Holding down the increment key for about two second moves to the peak hold & instant mode.
- 2) Changes the value or content of a selected digit. (Increments the value)



- 1) Holding down the increment key for about one second moves to the peak hold & instant clear mode.
- 2) Changes the digit to be set.



- 1) Store current condition and exit.



+



= Parameter setting mode



+



= Relay setting mode



+



= Digital zero function



+



= Key LOCK or Key LOCK clear mode

Rear Panel

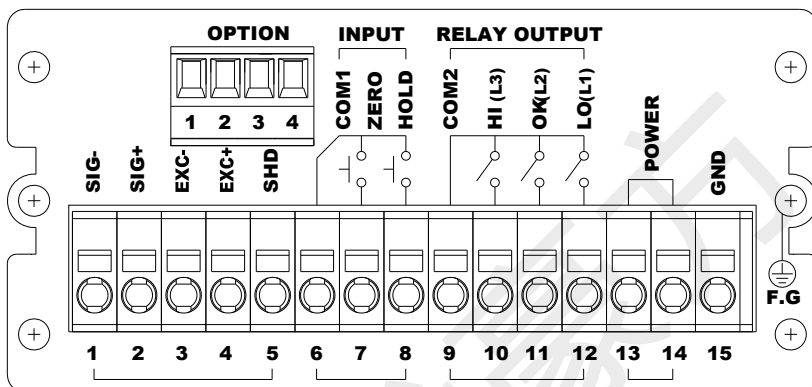

■ **GND (GROUND)** : It is a grounding terminal.

Ground it to prevent an electric shock and a trouble of static electricity.

■ **POWER(AC IN)** :

Use a stable power supply AC110/220V $\pm 10\%$, 50/60Hz

– Set up voltage AC220V

Connect power supply to terminals No.13(L) and No.14(N).

Pin No.	명칭	내용
13	POWER	Power terminal without polarity for both DC and AC (DC)
14	POWER	Power terminal without polarity for both DC and AC (DC)
15	GND	Ground

※ When using DC24V, it can be connected regardless of polarity.

■ **LOAD CELL** : Please connect the indicator connector with the wire of load cell according to the color.

Pin no.	Signal name	Contents
1	SIG- (Blue)	Load cell output (-)
2	SIG+ (Green)	Load cell output (+)
3	EXC- (White)	Load cell Input Voltage (-)
4	EXC+ (Red)	Load cell Input Voltage (+)
5	SHIELD	Shield

The wire color of load cell according to a manufactures.

Maker	1 SIG-	2 SIG+	3 EXC-	4 EXC+	5 SHIELD
BONGSHIN	BLUE	GREEN	WHITE	RED	SHIELD
CAS, TMI, AND	BLUE	GREEN	WHITE	RED	SHIELD
BLH	RED	WHITE	BLACK	GREEN	YELLOW
INTERFACE	WHITE	GREEN	BLACK	RED	SHIELD
KYOWA	WHITE	GREEN	BLACK	RED	SHIELD
P.T.	WHITE	GREEN	BLACK	RED	SHIELD
SHOWA	BLACK	WHITE	BLUE	RED	SHIELD
SHINKOH	WHITE	GREEN	BLACK	RED	SHIELD
TML	GREEN	WHITE	BLACK	RED	SHIELD
TFAC	BLACK	WHITE	BLUE	RED	YELLOW
HUNTLEIGH	WHITE	RED	BLACK	GREEN	SHIELD

※ Because wire color may be different according to a manufacture and load cell models. Please refer for the data sheet of load cell.

Cautions 1. When connecting a six-wire type strain gage sensor, short-circuit (EXC+ and SEN+)(EXC- and SEN-), respectively.

Cautions 2. Applied voltages to the strain gage sensor are 10. When any sensor rated below the applied voltage is connected, it may generate heat or be damaged

■ **IN-PUT** : COM1, ZERO, HOLD

This key is to control a equipment from the outside .

Please connect between COM terminal and each input terminal .

Because the power of input terminal was connected with 12V voltage
From the inside.

* An electric current is about 10mA.

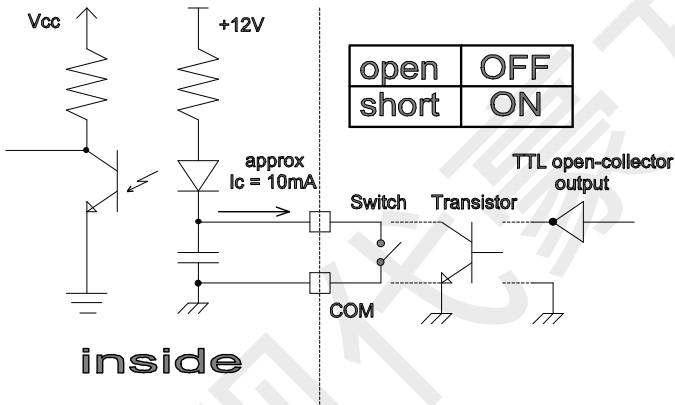

* Please make the minimum time to input a data with over 50msec.

Pin No.	Name	Description
6	COM1	Common for all external control terminals.
7	ZERO	Control for digital zero function. Enabled when short-circuited or at the same potential as COM.
8	HOLD	Control for hold function. Enabled when short-circuited or at the same potential as COM.

■ **RELAY OUTPUT** : COM2, HI(L3), OK(L2), LO(L1)

Connect between COM terminal and OUTPUT terminal
With the earth of no electric power.

Please use the output data For a signal only, don't use it for working.

Max earth capacity : AC250V / 0.5A

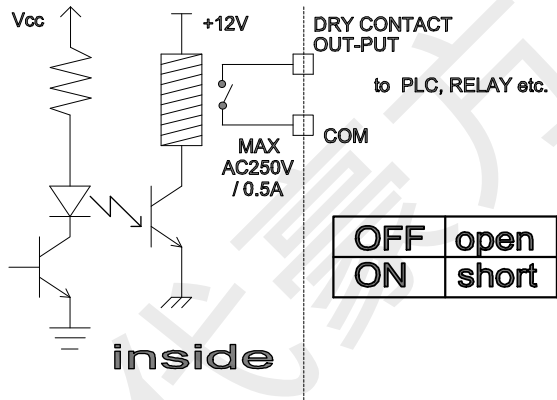

Pin No.	Name	Description
9	COM2	Common terminal for relay output
10	HI (L3)	HI (L3) output terminal (a, b contact)
11	OK (L2)	OK (L2) output terminal (a, b contact)
12	LO (L1)	LO (L1) output terminal (a, b contact)

- **OPTION** : Analog output (0~10V, 4~20mA) & Serial communication (RS-232C, RS-422/485) option.

Analog output (0~10V, 4~20mA) option

Pin No.	Name	Description
1	V-OUT	Voltage output terminal (0 to 10V)
2	COM	Common terminal for analog output.
3	COM	Common terminal for analog output.
4	A-OUT	Current output terminal (4 to 20mA)

Serial output (RS-232C) option

Pin No.	Name	Description
1	RX	RS-232C reception
2	TX	RS-232C transmission
3	SG	Common terminal for communications
4	NC	Do not connect this terminal

Serial output (RS-422) option

Pin No.	Name	Description
1	RXD (-)	RS-422 RX(-)
2	RXD (+)	RS-422 RX(+)
3	TXD (-)	RS-422 TX(-)
4	TXD (+)	RS-422 TX(+)

Serial output (RS-485) option

Pin No.	Name	Description
1	NC	Do not connect this terminal
2	NC	Do not connect this terminal
3	TXD (-)	RS-485
4	TXD (+)	RS-485

► TERMINAL BLOCK

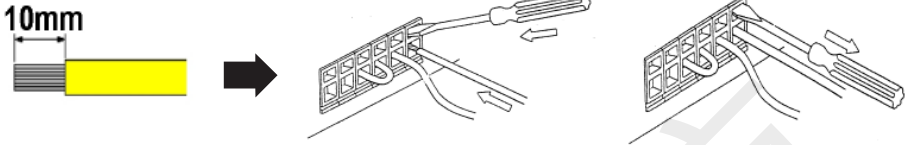

► AC Voltage change

Available to change AC110/220V with multiple.

Before setting up, please confirm the power voltage.

Please change the connect terminal of 110V/220V after opening the cover. If you need to change. (It was setted with AC220V at the first)

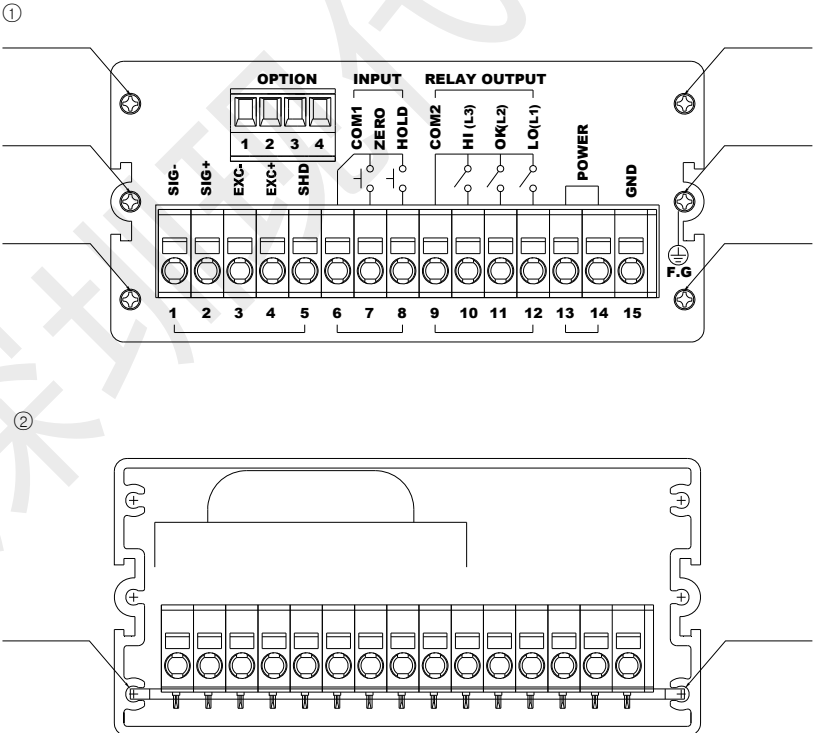

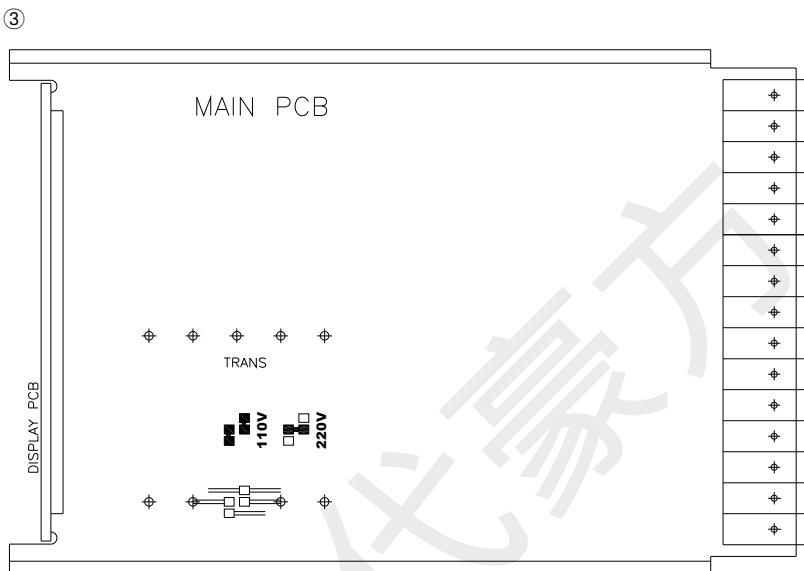

AC 220V change

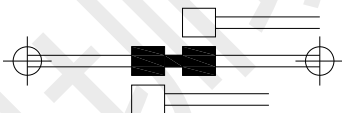

AC 110V change

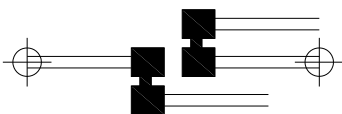

Information on Each Parameter

Indication	Name	Setup options	Default value
Calibration data			
LC.CAL	Load cell Rated output set	1 mV/V ~3 mV/V	2.0000
SCALE	Maximum Capacity set	0~99999	10000
At.CAL	Span weight set	0~99999	20000
Function data			
biP	Display Mode	biP (+/- display)/ uniP (+ display)	biP
dP.2	Decimal Point set	0(0)/1(0.0)/2(0.00)/3(0.000)/4(0.0000)	2
ds.1	Minimum Division set	1/ 2/ 5/ 10/ 20/ 50/ 100/ 200 digit	1
dU.2	Number of average operations setup	1/ 2/ 5/ 10/ 25/ 50	2
Zt.oFF	Zero Tracking set	OFF/ON	OFF
AZ.oFF	Auto zero backup set	OFF/ON	OFF
Hd.oFF	Hold function set	OFF(No used) /P(Peak Hold)/ I(Instant Hold)	OFF
tare	Manual Tare weight set	0~99999	00000
Condition data (Serial interface option)			
Id.0	Equipment ID setup	0 ~15	0
r.232	Communica- tion select	r.232(RS-232C)/r.422(RS-422)/ r.485(RS-485)	r.232
r.9600	Baud rate setup	1200/2400/4800/9600/1920(19200)/ 3840(38400)	9600
Par.no	Parity bit	Par.no(None)/Par.Ev(Even)/Par.Od(Odd)	Par.Ev
Rc.on	Communica- tion mode	ON(Data is required)/OFF(Stream mode)	ON

Condition data (Analog output option)			
dA.LO	Analog output LO indication setup	0~99999	00000
dA.HI	Analog output HI indication setup	0~99999	10000

Indication	Name	Setup options	Default value
Comparator data			
rLY.1H	L1 HI side judgment value setup	-9999 ~ 99999	10000
rLY.1L	L1 LO side judgment value setup	-9999 ~ 99999	10000
r1H.on	L1 Relay motion mode	r1H.on / r1L.on/ r1r.on	r1H.on
rLY.2H	L2 HI side judgment value setup	-9999 ~ 99999	9999
rLY.2L	L2 LO side judgment value setup	-9999 ~ 99999	5001
r2H.on	L2 Relay motion mode	r2H.on / r2L.on/ r2r.on	r2H.on
rLY.3H	L3 HI side judgment value setup	-9999 ~ 99999	5000
rLY.3L	L3 LO side judgment value setup	-9999 ~ 99999	5000
r3H.on	L3 Relay motion mode	r3H.on / r3L.on/ r3r.on	r3H.on

1. Calibration data

1-1 Load cell rated output set (LC.CAL)

- . Set the rated output value(mV/V value) for the strain gauge sensor.
- . The setting range of the rated output value for strain gauge sensor is 0.1 to 3.0 mV/V.

1-2 Maximum Capacity set (SCALE)

- . Set the indicated value when the rated output value is acquired and finalized.
- . Setting range of SCALE set value (indicated value) 100 to 99999.
- . Acquire both load cell rated output set value and measured value (SCALE value) and finalize with “ENTER” key.

1-3 Span weight set (At.CAL)

- . Actual load is performed by applying actual load to the connected strain gauge sensor, and by setting the indicated value (SPAN set value) at the time.
- . Setting range of SCALE set value (indicated value) 100 to 99999.
- . Resolution in this meter is 20000 at the time of a 2.0000 mV/V value.

2. Function data

2-1 Display mode (biP)

- . “biP” +/- display, “uniP” + display, “

2-2 Decimal point set (dP.2)

- . Set the decimal point position displayed on the set-value select screen.
- . Setting items : 0(0), 1(0.0), 2(0.00), 3(0.000), 4(0.0000)

2-3 Minimum Division set (ds.1)

- . Set the minimum updating width of indicated values.
- . Set it on the set-value select screen.
- . Setup items : 1, 2, 5, 10, 20, 50, 100, 200

2-4 Average operations setup (dU.2)

- . This function is provided for the moving average of data after A/D conversion so as to reduce the fluctuation of the indicated values.
- . As the number of times of moving average is increased, the indicated value is stabilized. However response becomes slow.

- . Set it on the set-value select screen.
- . Setup items : 1, ,2, 5, 10, 25, 50

2-5 Zero Tracking set (Zt.oFF)

- . This function is provided to correct automatically the slow change of the zero point due to a change in the environment etc.
When the indicated value is below the ZT width, the indicated value is set to "0" and internal correction is performed at every ZT cycle.

2-6 Auto ZERO backup set (AZ.oFF)

- . ON/OFF setting can be performed by pressing by pressing the "increment" key one at a time.
- . When backup is set to OFF, Digital ZERO continues even when power is turned OFF/ON.

2-7 HOLD Function set (Hd.oFF)

- . This function is provided to detect one sample with a peak, instant hold, and point of inflection, holds the indicated value, performs HI/OK/LO limit comparison simultaneously, and outputs the result.
- . Turning on Hold control terminal signal with both "HOLD" key turned on will not be accepted. Priority is given to "HOLD" key.
- . **Peak HOLD :**
The peak hold function retains one of the maximum values and provides output for that value. Selection from these values is made using the hold function data.
- . **Instant HOLD :**
The Hold function temporarily retains the indication.

2-8 Manual TARE Weight set (tare)

- . The purpose of using tare is to subtract a certain weight on the real weight.
- . When you already know the tare weight, press key tare and input tare weight with arrow keys and memorize it by pressing "ENTER" key.
- . Setting range of TARE set value (indicated value) 99999.

3. Condition data (Serial Interface option)

3-1 Equipment ID setup (Id.0)

- . The ID is necessarily required to connect several indicators to control together with a host PC.
- . Setting range : 0 to 15

3-2 Communication select (r.232)

- . Select RS-232C/RS-422/RS-485 communication.
 - . Setup items : r.232(RS-232C)/r.422(RS-422)/r.485(RS-485)

3-3 Baud rate setup (r.9600)

- . To enable the communication mode, proper baud rate should be set within r1200~r3840, in which r1920 means 19200bps and r3840 means 38400bps.
- . Setup items : 1200, 2400, 4800, 9600, 1920(19200), 3840(38400)

3-4 Parity bit setup (Par.Ev)

- . Communication parity bit set..
- . Setup items : Par.no(None)/Par.Ev(Even)/Par.Od(Odd)

3-5 Communication mode setup (Rc.on)

- . Rc on : Transmit when data is required
- . Rc off : Stream mode
- . Serial communication protocol.

4. Condition data (Analog output option)**4-1 Analog output LO indication setup** (dA.LO)

- . Set an indicated value when analog output is 0V or 4mA.
- . Setting range : 0 to 99999

4-2 Analog output HI indication setup (dA.HI)



- . Set an indicated value when analog output is 10V or 20mA.
- . Setting range : 0 to 99999

ZERO Calibration

The digital zero function zeros the indication given at an arbitrary timing. Thereafter, the function shows the amount of change from the point of zeroing. However, this function serves as an indication resetting function for a frequency measuring unit. Thus, the digital zero function can be used to reset the indication when there is no input signal at all.

Note that, the on/off control of the digital zero function can be achieved by means of terminal control or front panel keys. In the case of terminal control, the digital zero function is turned on by short circuiting the ZERO and COM1 terminals or setting both terminals to the same voltage level. The indication at that moment is zeroed. In the case of control with the front panel keys, hold down the enter key and press the increment for about 1 second to zero the indication at that moment.

1. Method of Setting zero

Pressing the  key while pressing the  key and zero set mode.

※ **Note** : The setup condition are protect clear.

If these conditions are not satisfied, an error indication appears and the display returns.

2. Digital ZERO Backup

Function data			
AZ.oFF	Auto zero backup set	OFF/ON	OFF



ON/OFF setting can be performed by pressing by pressing the “increment” key one at a time.

When backup is set to OFF, Digital ZERO continues even when power is turned OFF/ON.

Actual Load Calibration

Actual load calibration means that calibration is carried out by applying actually measured pressure to a sensor such as a load cell connected to the meter.

1. Method of setting

Pressing the  key while pressing the  key

and actual load calibration mode. (CAL MODE)

2. Calibration Menu (CAL 1 ~ CAL 5)

L.C.CAL ⇄ SCALE ⇄ A.L.CAL ⇄ b.i.P ⇄
 dP. 2 ⇄ dS. 1 ⇄ dU. 2 ⇄ 2t.oFF ⇄
 R2.oFF ⇄ HdoFF ⇄ tDrE ⇄ Id. 0 ⇄
 r.232 ⇄ r.9600 ⇄ PDr.Eu ⇄ r.Con ⇄
 dRL0 ⇄ dRH 1 ⇄ -End-

CAL 1 : Zero Calibration

CAL 2 : Rated Output set

CAL 3 : Maximum Capacity set

CAL 4 : Setting Weight & Span Calibration

CAL 5 : End

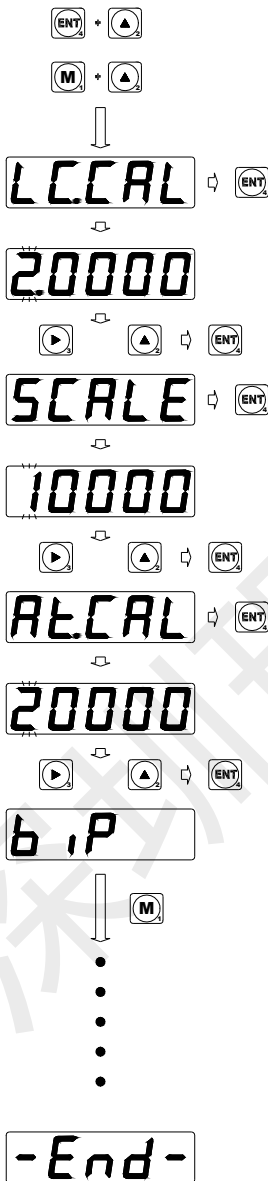



- ① Press the increment key, and enter key together during measurement.
(Digital zero)
- ② Press the increment key, and mode key together during measurement.
- ③ Press the enter change to the equivalent calibration mode.
- ④ Press the shift key (change digit) and increment key (change numeric value) to set load cell rated output. (specifications)
(example : 2mV/V)
Press the enter key to move to the maximum capacity mode.
- ⑤ Press the enter key. Press the shift key (change digit) and increment key (change numeric value) to set load cell maximum capacity. (specifications)
(example : 10000kg)
Press the enter key to move to the span calibration mode.
- ⑥ Press the enter key to change to the span indicating value setup mode.
Press the shift key (change digit) and increment key (change numeric value) to set 20000.
Press the enter key to move to the function data mode.
- ⑦ Press mode or enter key to return to the measurement mode.

Equivalent Calibration

Equivalent calibration means that calibration is carried out according to the ratings (specifications) of such a sensor as a load cell. It is not necessary to connect the sensor or to apply pressure to the sensor. Set the rated value for the strain gauge sensor and the indicated value at the time. Equivalent calibration can be performed only by setting the rated output(mV/V) of the strain gauge sensor and the indicated value at the time, without actual load.

1. Method of setting

Pressing the  key while pressing the  key and equivalent calibration mode. (CAL MODE)

2. Calibration Menu (CAL 1 ~ CAL 4)

L.C.CAL ⇄ SCALE ⇄ R.L.CAL ⇄ b.i.P ⇄
 d.P. 2 ⇄ d.S. 1 ⇄ d.U. 2 ⇄ 2.t.o.F.F. ⇄
 R2.o.F.F. ⇄ H.d.o.F.F. ⇄ t.a.r.P. ⇄ l.d. 0 ⇄
 r.232 ⇄ r.9600 ⇄ P.a.r.E.u. ⇄ r.C.on ⇄
 d.R.L.O ⇄ d.R.H.1 ⇄ -End-

CAL 1 : Zero Calibration

CAL 2 : Rated Output set

CAL 3 : Maximum Capacity set

CAL 4 : End

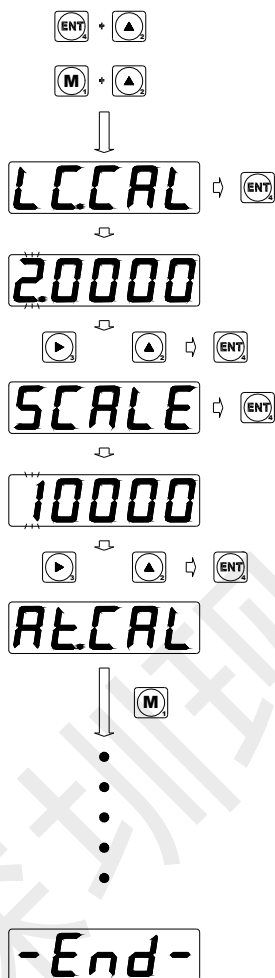



- ① Press the increment key, and enter key together measurement. (Digital zero)
- ② Press the increment key, and mode key together during measurement.
- ③ Press the enter change to the equivalent calibration mode.
- ④ Press the shift key (change digit) and increment key (change numeric value) to set load cell rated output. (specifications) (example : 2mV/V)
Press the enter key to move to the maximum capacity mode.
- ⑤ Press the enter key. Press the shift key (change digit) and increment key (change numeric value) to set load cell maximum capacity. (specifications) (example : 10000kg)
Press the enter key to move to the span calibration mode.
- ⑥ Press mode key to return to the measurement mode.









※ Press not enter key.

Comparator Data (Relay setting)

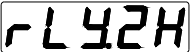
1. Method of setting

Pressing the  key while pressing the  key and equivalent calibration mode. (Comparator MODE)

2. Calibration Manu

 ⇨  ⇨  ⇨
 ⇨  ⇨  ⇨
 ⇨  ⇨  ⇨

3. Output Specifications

Conditions for comparison	Judgment result
Indicated value > Upper limit judgment value	HI
Lower limit judgment value \leq Indicated value \leq Upper limit judgment value	OK
Lower limit judgment value > Indicated value	LO

4. Method of Setting Comparator Data (L1 ~ L3)

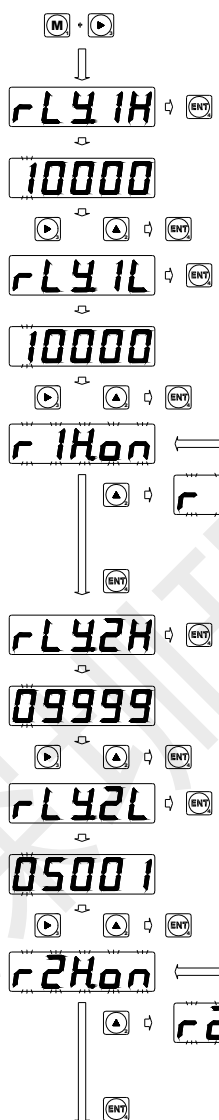

- ① Press the shift key, and mode key together during measurement.
- ② Press the enter key to change to the relay 1 High setup mode.
- ③ Press the shift key (change digit) and increment key (change numeric value) to set relay 1 High output. (example : 10000)
Press the enter key to move to the relay 1 Low setup mode.
- ④ Press the enter key. Press the shift key (change digit) and increment key (change numeric value) to set relay 1 Low.
Press the enter key to move to the relay mode.
- ⑤ Press increment key a few times set the relay mode.
Press the enter key to change to the relay 2 High setup mode.
- ⑥ The same method applies to other parameters.

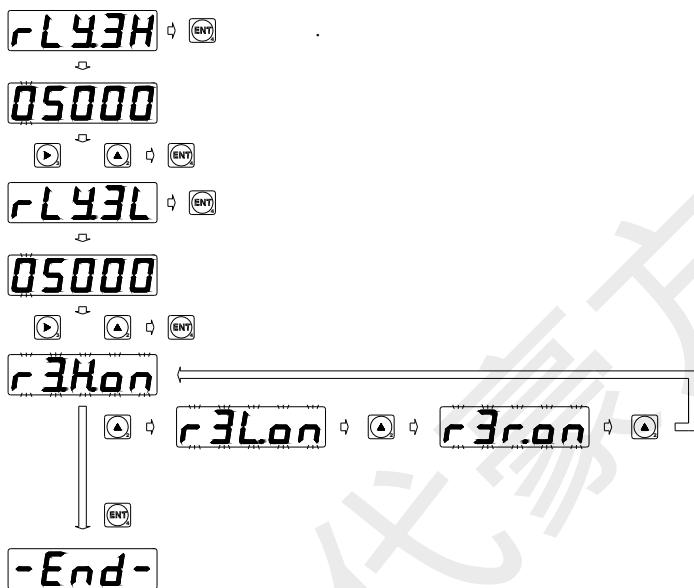

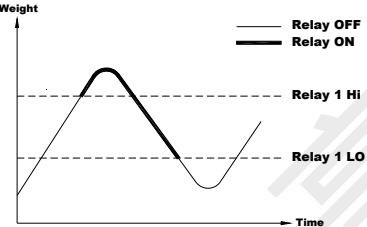
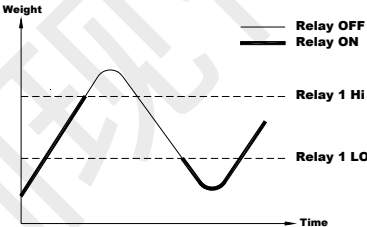
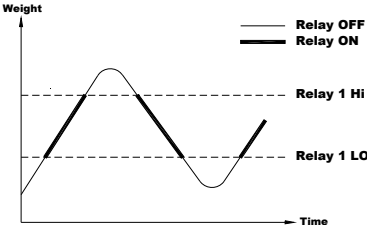
Indication	Setup options
Relay mode	(r1H.on / r1L.on/ r1r.on)
r1H.on	<p>The r1H.on mode means the relay 1 motion mode, in which the load within the limits will activate a relay on and the load beyond the limits will activate a relay off.</p>  <p>The graph shows Weight on the vertical axis and Time on the horizontal axis. Two horizontal dashed lines represent Relay 1 Hi (upper) and Relay 1 LO (lower). A weight curve starts below LO, rises between LO and Hi, then falls below LO, and finally rises above Hi. The relay is ON (thick line) only when the weight is between LO and Hi.</p>
r1L.on	<p>The r1L.on mode means the relay 1 motion mode, in which the load within the limits will activate a relay off and the load beyond the limits will activate a relay on.</p>  <p>The graph shows Weight on the vertical axis and Time on the horizontal axis. Two horizontal dashed lines represent Relay 1 Hi (upper) and Relay 1 LO (lower). A weight curve starts below LO, rises between LO and Hi, then falls below LO, and finally rises above Hi. The relay is OFF (thin line) only when the weight is between LO and Hi.</p>
r1r.on	<p>The r1r.on mode means the range mode, in which the load within the limits will activate a relay on and the load beyond the limits will activate LO LED on as a warning of high NG or low NG.</p>  <p>The graph shows Weight on the vertical axis and Time on the horizontal axis. Two horizontal dashed lines represent Relay 1 Hi (upper) and Relay 1 LO (lower). A weight curve starts below LO, rises between LO and Hi, then falls below LO, and finally rises above Hi. The relay is ON (thick line) only when the weight is between LO and Hi.</p>

※ The same method applies to other parameters.

5. Relay Motion Mode

5-1 HI ON relay motion mode : r1H.on, r2H.on, r3H.on

: The load within the limits will activate a relay ON.

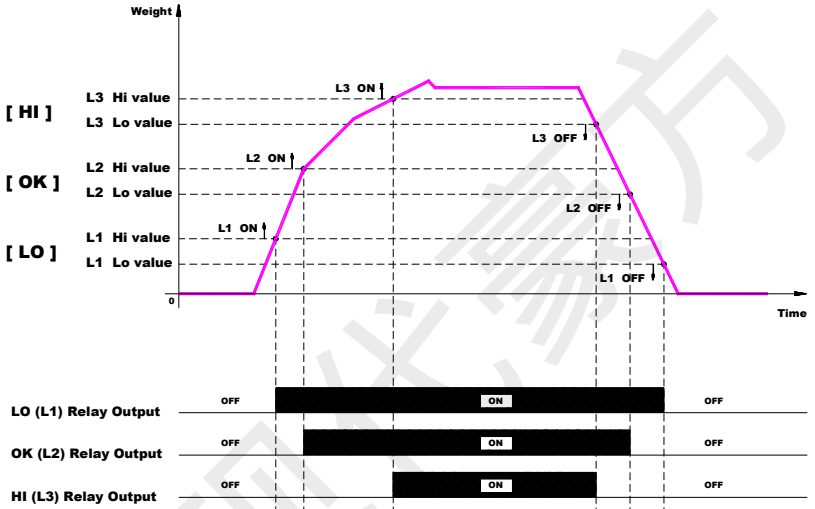

Example 1)

HI ON mode	rLY.1H	L1 HI side judgment value	1000	1000 within the limits will activate a relay ON
	rLY.1L	L1 LO side judgment value	900 (or 1000)	900 beyond the limits will activate a relay OFF
	rLY.2H	L2 HI side judgment value	2000	2000 within the limits will activate a relay ON
	rLY.2L	L2 LO side judgment value	1900 (or 2000)	1900 beyond the limits will activate a relay OFF
	rLY.3H	L3 HI side judgment value	3000	3000 within the limits will activate a relay ON
	rLY.3L	L3 LO side judgment value	2900 (or 3000)	2900 beyond the limits will activate a relay OFF

5-2 LO ON relay motion mode : r1L.on, r2L.on, r3L.on
: The load within the limits will activate a relay OFF.

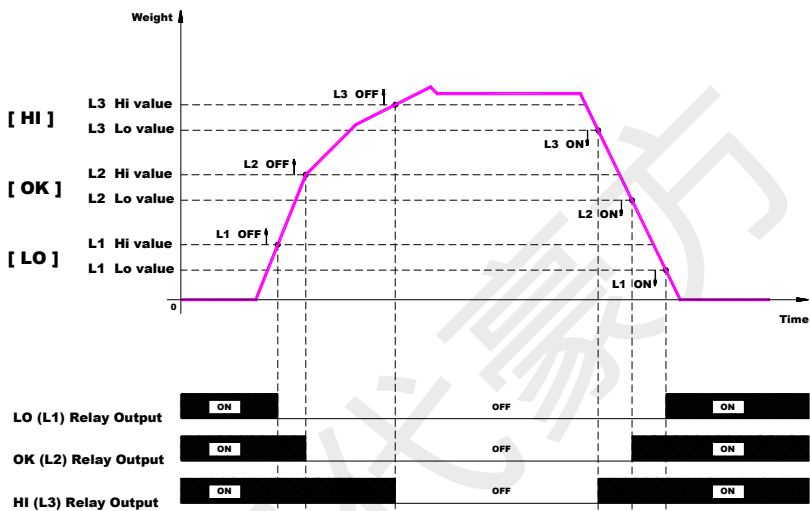

Example 1)

LO ON mode	rLY.1H	L1 HI side judgment value	1000	1000 within the limits will activate a relay OFF
	rLY.1L	L1 LO side judgment value	900	900 beyond the limits will activate a relay ON
	rLY.2H	L2 HI side judgment value	2000	2000 within the limits will activate a relay OFF
	rLY.2L	L2 LO side judgment value	1900	1900 beyond the limits will activate a relay ON
	rLY.3H	L3 HI side judgment value	3000	3000 within the limits will activate a relay OFF
	rLY.3L	L3 LO side judgment value	2900	2900 beyond the limits will activate a relay ON

- 5-3 Range ON relay motion mode : r1r.on, r2r.on, r3r.on
 : Indicates the result of judgment and turns on
 if LO judgment value \leq the measured value \leq Hi judgment value.

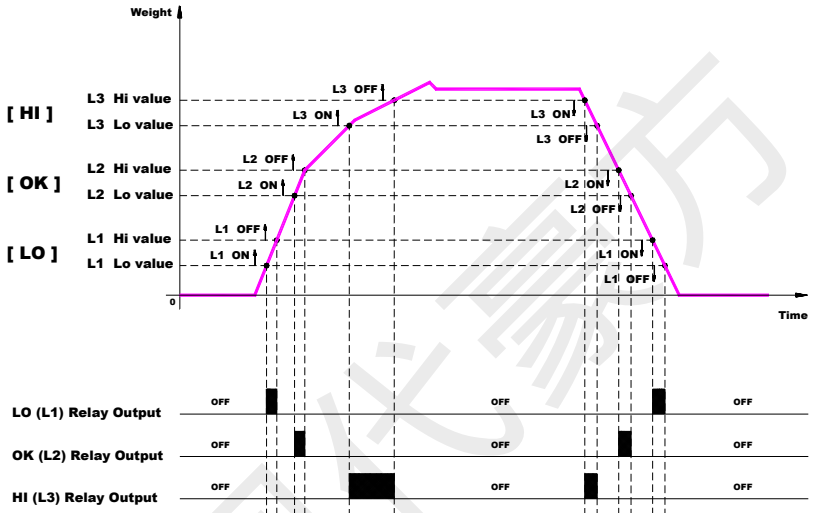

Example 1).

Range mode	rLY.1H	L1 HI side judgment value	1000	1000 within the limits will activate a relay OFF
	rLY.1L	L1 LO side judgment value	900	900 within the limits will activate a relay ON 900 beyond the limits will activate a relay OFF
	rLY.2H	L2 HI side judgment value	2000	2000 within the limits will activate a relay OFF
	rLY.2L	L2 LO side judgment value	1900	1900 within the limits will activate a relay ON 1900 beyond the limits will activate a relay OFF
	rLY.3H	L3 HI side judgment value	3000	3000 within the limits will activate a relay OFF
	rLY.3L	L3 LO side judgment value	2900	2900 within the limits will activate a relay ON 2900 beyond the limits will activate a relay OFF

5-4 Comparator weighing mode : r1L.on, r2r.on, r3H.on

: Indicates the result of judgment and turns on

if L1 judgment value \leq L2 judgment value \leq L3 judgment value.

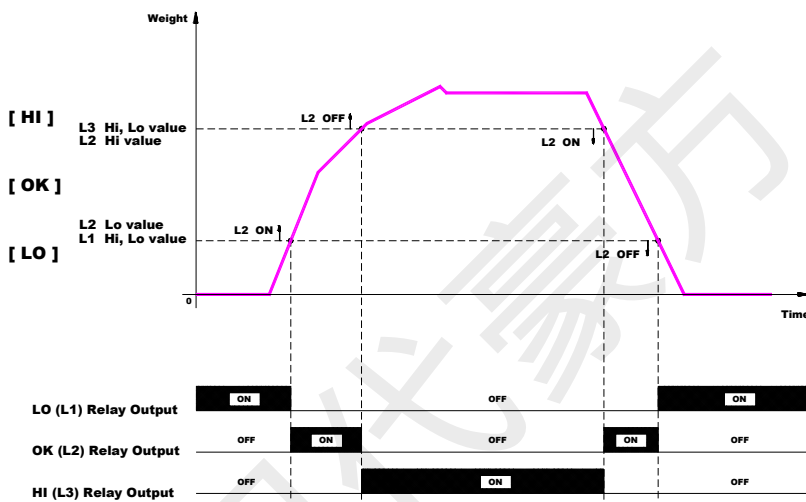

Example 1)

L1 – LO ON mode	rLY.1H	L1 HI side judgment value	1000	1000 beyond the limits will activate a relay ON
	rLY.1L	L1 LO side judgment value	1000	1000 within the limits will activate a relay OFF
L2– Range mode	rLY.2H	L2 HI side judgment value	3000	3000 within the limits will activate a relay OFF
	rLY.2L	L2 LO side judgment value	1000	3000 beyond the limits will activate a relay OFF In the range of relay ON
L3 – HI ON mode	rLY.3H	L3 HI side judgment value	3000	3000 within the limits will activate a relay ON
	rLY.3L	L3 LO side judgment value	3000	3000 beyond the limits will activate a relay OFF

Hold Function

1. Hold Function

The Hold function temporarily retains the indication. The hold function is enabled by short circuiting the HOLD and COM terminals or setting both terminals to the same voltage level. As a result the display unit retains the indication given at that moment.

Hd.oFF	Hold function set	OFF(No used) /P(Peak Hold)/ I(Instant Hold)	OFF
--------	-------------------	--	-----

Method of setting Hold data

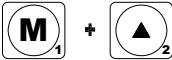

Press the increment and mode keys together during measurement.

Press the mode key a nine times to display the hold mode data menu. Press the increment key a few times to display the parameter to be set. Press the enter key to set. Press the enter or mode key to the measurement mode.

Indication	Setup options
HOLD mode (Hd.oFF / Hold.P/ Hold.I)	
	No used (Hold off)
	<p>- Peak HOLD -</p> <p>The peak hold function retains one of the maximum values and provides output for that value. Selection from these values is made using the hold function data.</p>

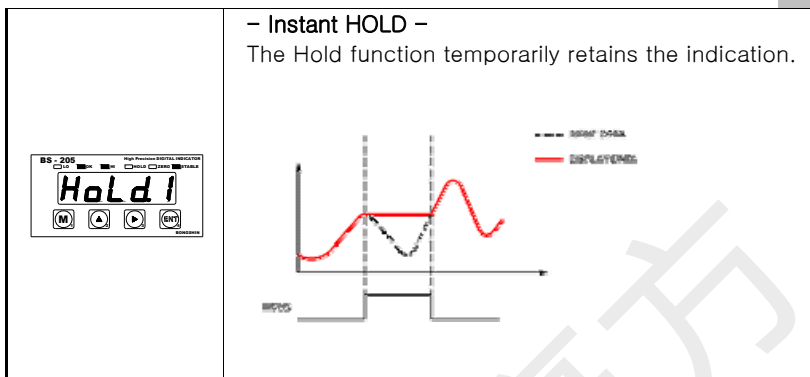

2. Method of Setting Hold



KEY HOLD

Press the “Increment” key for about 1.5 second.

External HOLD Controls

The hold function is enabled by short circuiting the HOLD and COM1 terminals or setting both terminals to the same voltage level.

- ※ The hold function is not disabled if the control terminal are made to go through the on-off-on sequence with the function enabled by means of the front panel keys.

3. Method of Setting Hold clear



KEY HOLD Clear

Press “shift” key.

External HOLD Clear Controls

The hold function is enabled by short circuiting the HOLD and COM1 terminals or setting both terminals to the same voltage level.

KEY Lock or KEY Lock clear

1. Method of Setting KEY Lock

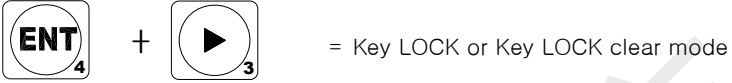

Press the shift key and enter keys together during measurement.
Protect others.

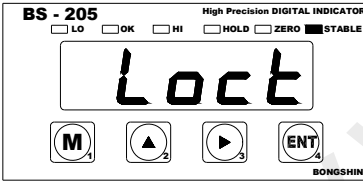

2. Method of Setting KEY Lock clear

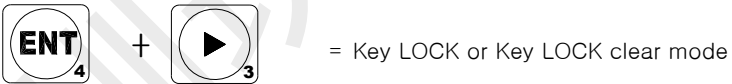

Press the shift key and enter keys together during measurement.

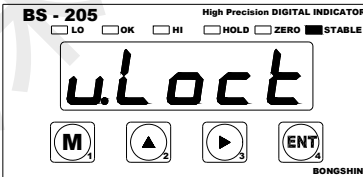

Option

1. RS-232C Serial Interface (Option-1)

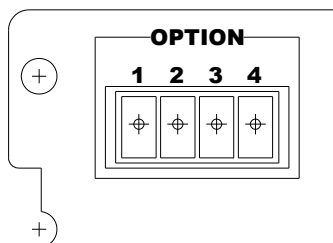

Pin No.	Name	Description
1	RXD	RS-232C reception
2	TXD	RS-232C transmission
3	SG	Common terminal for communications
4	NC	Do not connect this terminal

► Function

Condition data (Serial interface option)			
Id.0	Equipment ID setup	0 ~15	0
r.9600	Baud rate setup	1200/2400/4800/9600/1920(19200)/3840(38400)	9600
Rc.on	Communication mode	ON(Data is required)/OFF(Stream mode)	ON

► Signal Format

- Type : EIA-RS-232C
- Method : Full-Duplex , Asynchronous, Bi-direction
- Baud rate : 1200, 2400, 4800, 9600, 19200, 38400bps (Baud-Rate)
- Format :
 - ① Data Bit : 8 (NO Parity)
 - ② Start/Stop : 1 bit
 - ③ Parity Bit : None/Even/Odd select
 - ④ Code : ASCII

► Serial Communication Protocol

The below describe an example on the settings for communication between an indicator and a PC assuming that current display is 32.567 and the ID of a indicator is 5.

1) Transfer the current display from host PC

Byte 1 (Indicator ID)	Byte 2
35H	R(52H)

Response from Indicator

Byte 1	Byte 2	Byte 3	Byte 4	Byte 5	Byte 6
STX(02H)	35H	+(2BH)	3(33H)	2(32H)	.(2EH)
Byte 7	Byte 8	Byte 9	Byte 10		
5(35H)	6(36H)	7(37H)	ETX(03H)		

2) Special Functions Set

Host (PC)			Indicator
Auto Zero set	Byte 1 (Indicator ID)	Byte 2	No response
	35H	Z(5AH)	
Hold set	Byte 1 (Indicator ID)	Byte 2	Transfer again to enable
	35H	H(48H)	
Hold clear set	Byte 1 (Indicator ID)	Byte 2	Transfer again to disable
	35H	L(4CH)	

Example) 1(ID)+_7.487

ASCII	1+_7.487
HEXA	02 31 2B 20 37 2E 34 38 37 03

Example) 1(ID)+_ _7487

ASCII	1+_ _7487
HEXA	02 31 2B 20 20 37 34 38 37 03

Example) 15(ID)+_7486

ASCII	15+_7486
HEXA	02 3F 2B 20 2E 37 34 38 36 03

Example) 2(ID)+_74.86

ASCII	2+_74.86
HEXA	02 32 2B 20 37 34 2E 38 36 03

■ Connection of RS-232C

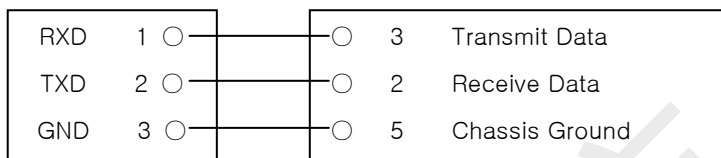

RS-232C port of
BS-205

9 pin serial port
of computer

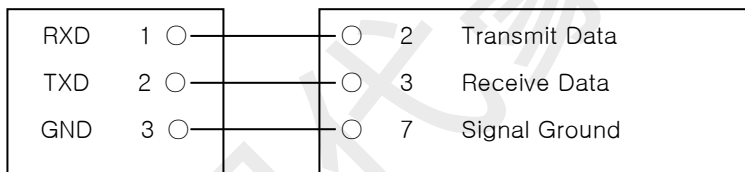

RS-232C port of
BS-205

25 pin serial port
of computer

2. RS-422/485 Serial Interface (Option-2, 3)

- RS-422 is to transmit the signal by the power difference. Also, it is more safety rather other interface system for a electric noise.
- Specially please use the cable with shield coax cable surely.
- Recommended distance is under 1.2 km.
- Both end side of a wire must be connected by the termination of 300Ω .

▶ **Signal Format** : Same as RS-232C

▶ **Data Format** : Same as RS-232C

▶ **Connecting method of RS-422/485 port**

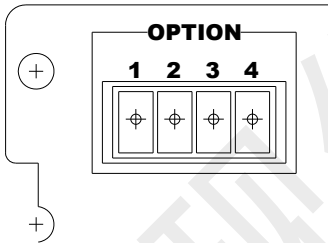

■ Serial output (RS-422) option

Pin No.	Name	Description
1	RX (-)	RS-422 RX(-)
2	RX (+)	RS-422 RX(+)
3	TX (-)	RS-422 TX(-)
4	TX (+)	RS-422 TX(+)

■ Serial output (RS-485) option

Pin No.	Name	Description
1	NC	Do not connect this terminal
2	NC	Do not connect this terminal
3	TXD (-)	RS-485
4	TXD (+)	RS-485

3. Voltage (0~10V) Analog Output (Option-4)

The BS-205 series of unit meters can output an analog signal for an indicated value.(when the meter is equipped with an analog output unit)

The analog output of the BS-205 series allows for arbitrary output scaling.

This scaling can be achieved by setting the indication value for an output of the maximum scale value(10V for 0~10V output range) in the dA.HI parameter of the scaling data.

The voltage output occurs proportionally the voltage according to the size of a weight in 0V ~10V.

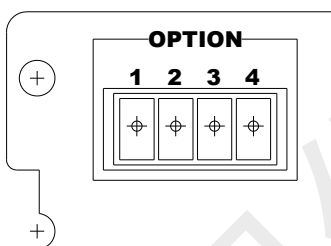

Analog output (0~10V, 4~20mA) option

Pin No.	Name	Description
1	V-OUT	Voltage output terminal (0 to 10V)
2	COM	Common terminal for analog output.
3	COM	Common terminal for analog output.
4	A-OUT	Current output terminal (4 to 20mA)

■ SPECIFICATION

output Voltage	0 ~ 10V DC out
Precision	Max 1/1000
Min Impedance	Over 1 kΩ

Condition data (Analog output option)			
	Analog output LO indication setup	0~99999	00000
	Analog output HI indication setup	0~99999	10000

1) Analog Output LO

- . Set an indicated value when analog output is 0V or 4mA.
- . Setting range : + 99999

2) Analog Output HI

- . Set an indicated value when analog output is 10V or 20mA.
- . Setting range : + 99999
- . Example of analog output setting
Set the indicated value when analog output is 0V(or 4mA) to 400.
Set the indicated value when analog output is 10V(or 20mA) to 2000.

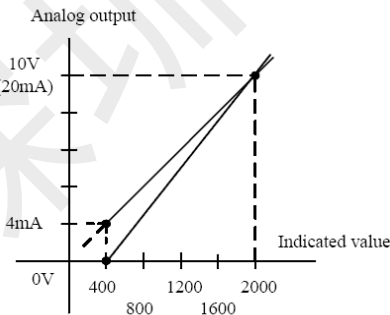

Note 1) When the indicated value becomes larger than analog output set value, it is not properly output.

Note 2) When the indicated value is -OVER, and analog output is less than 0V, the output is near 0V.

4. Electric current (4~20mA) Analog Output (Option-5)

The BS-205 series of unit meters can output an analog signal for an indicated value.(when the meter is equipped with an analog output unit)

The analog output of the BS-205 series allows for arbitrary output scaling.

This scaling can be achieved by setting the indication value for an output of the maximum scale value(20mA for 4~20mA output range) in the dA.HI parameter of the scaling data.

The current output occurs proportionally the current according to the size of a weight in 4~20mA.

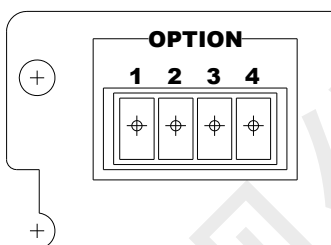

Analog output (0~10V, 4~20mA) option

Pin No.	Name	Description
1	V-OUT	Voltage output terminal (0 to 10V)
2	COM	Common terminal for analog output.
3	COM	Common terminal for analog output.
4	A-OUT	Current output terminal (4 to 20mA)

■ SPECIFICATION

output Voltage	4 ~ 20 mA DC Current out
Precision	Max 1/1000
Min Impedance	Under 500 Ω

Condition data (Analog output option)			
<p>BS - 205 High Precision DIGITAL INDICATOR <input type="checkbox"/> LO <input type="checkbox"/> OK <input type="checkbox"/> HI <input type="checkbox"/> HOLD <input type="checkbox"/> ZERO <input type="checkbox"/> STABLE (M) (▲) (▶) (ENT) SONGSHIN</p>	Analog output LO indication setup	0~99999	00000
<p>BS - 205 High Precision DIGITAL INDICATOR <input type="checkbox"/> LO <input type="checkbox"/> OK <input type="checkbox"/> HI <input type="checkbox"/> HOLD <input type="checkbox"/> ZERO <input type="checkbox"/> STABLE (M) (▲) (▶) (ENT) SONGSHIN</p>	Analog output HI indication setup	0~99999	10000

1) Analog Output LO

- Set an indicated value when analog output is 0V or 4mA.
- Setting range : + 99999

2) Analog Output HI

- Set an indicated value when analog output is 10V or 20mA.
- Setting range : + 99999
- Example of analog output setting
 Set the indicated value when analog output is 0V(or 4mA) to 400.
 Set the indicated value when analog output is 10V(or 20mA) to 2000.

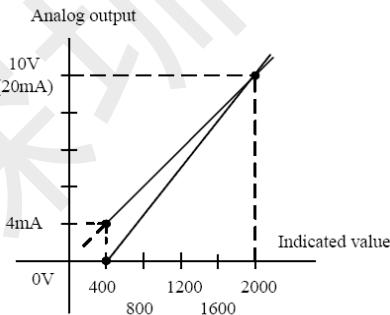

Note 1) When the indicated value becomes larger than analog output set value, it is not properly output.

Note 2) When the indicated value is -OVER, and analog output is less than 0mA, the output is near 0mA.

5. Parallel BCD Output (Option-6)

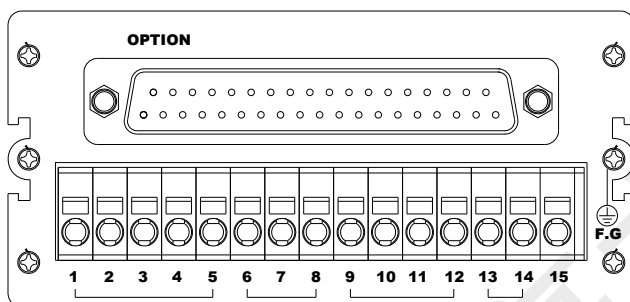

■ Pin assignment and circuit

Pin No.	SIGNAL	Pin No.	SIGNAL
1	GROUND/ (-) COMMON	20	4×10^4
2	1×10^0	21	8×10^4
3	2×10^0	22	
4	4×10^0	23	POLAR (+/-)
5	8×10^0	24	Decimal Point 10^1
6	1×10^1	25	Decimal Point 10^2
7	2×10^1	26	Decimal Point 10^3
8	4×10^1	27	Decimal Point 10^4
9	8×10^1	28	
10	1×10^2	29	
11	2×10^2	30	
12	4×10^2	31	BUSY
13	8×10^2	32	
14	1×10^3	33	GROUND/ (-)COMMON
15	2×10^3	34	
16	4×10^3	35	
17	8×10^3	36	ZERO (Input DC+24V)
18	1×10^4	37	ZERO (Input DC-24V)
19	2×10^4		

- Minus common connection

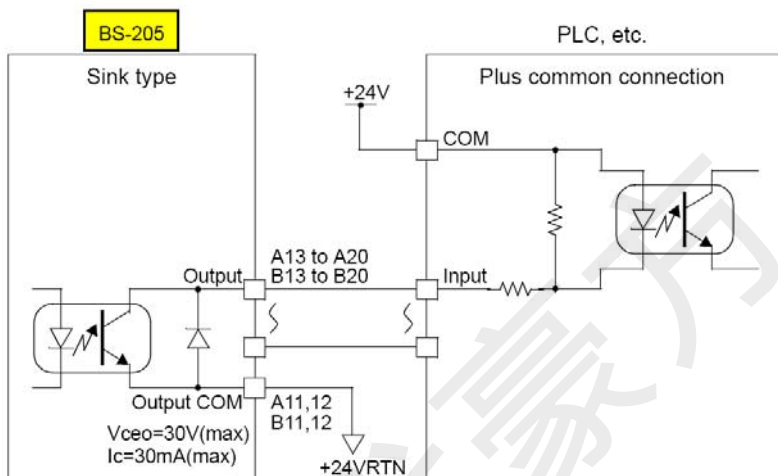

■ Data Transfer Mode

Setting of the BCD output is done with the general functions.

Condition data (Serial interface option)	
Name	Setting
Equipment ID setup	Id.0
Baud rate setup	r.9600
Communication mode	Rc.oFF

■ Signal Logic

- 1) Weight BCD DATA Output : Negative
- 2) Polarity Output : "+" = High
- 3) BUSY : "BUSY" = High

■ Specification

- 1) BCD output (NPN Open Collector Type)
- 2) Standard Accessory : 37P D-Type Female connector

Error Message and Trouble Shooting

ERROR	CAUSE	A/S	Reference.
Waving a weight Value.	① Load cell damage ② Insulation resistance badness of load cell. ③ Weighing part error	① Checking for Input, Output of load cell. Resistance Value. ② Checking Insulation Resistance value of Load cell.	① Input resistance : about 1130Ω ② Output resistance : about 1000Ω ③ Insulation Resistance : over100MΩ
A. Changing a Weight value, B. Not return to ZERO Appear "no.LC"	① Load cell damage.	① Checking Insulation Resistance value of Load cell. (Normal Max 100MΩ or -OL-appear)	
	① Disconnected to Load Cell.	① Confirm a connect of Load cell ② Checking a single wire Of load cell cable	
Weight (-) changed	① Load cell output (SIG+,SIG-)changed.	① Load cell connector	
Appear "Ovr" "-Ovr"	① Load cell damage ② Connection Error	① Load cell damage ② Load cell connector	
	① Excess Max weight	① Remove excess weight	